

N.b. ROD-EYE ORIENTATION NOT GUARANTEED.

ELECTRICAL OPTIONS/ SPECIFICATIONS

OUTPUT SUPPLY  
 0.5 TO 4.5V RATIO METRIC 5V  
 SUPPLY CURRENT 12mA TYP. 20mA MAX.

CABLE: 0.2mm<sup>2</sup>, 0/A SCREEN, PUR JACKET – SUPPLIED WITH 50cm OR REQUIRED LENGTH IN cm (15000cm MAX).  
 STANDARD 3-CORE: JACKET Ø4mm BLACK e.g. 'L50'  
 OPTIONAL 5-CORE: JACKET Ø4.6mm BLUE e.g. 'LQ50'

CABLE/CONNECTOR\* CONNECTIONS;  
 3 CORE 5 CORE CONNECTOR  
 RED RED :1 +Ve  
 - ORG :1 +SENSE (5-WIRE ONLY)  
 BLACK BLACK :3 0V  
 - GRY :3 -SENSE (5-WIRE ONLY)  
 WHITE WHITE :2 OUTPUT  
 SCREEN SCREEN :4 BODY

\*CONNECTORS; MAXIMUM CONDUCTOR CROSS SECTION 0.75mm<sup>2</sup>  
 RANGE OF DISPLACEMENT FROM 0–5mm TO 0–350mm e.g.76, IN INCREMENTS OF 1mm.

BODY MATERIAL: STAINLESS STEEL.

FURTHER OPTIONS:

SINGLE PAIR OF BODY CLAMPS 'P'

TWO PAIRS OF BODY CLAMPS 'P2'

PUSH-ROD FREE (CODE 'V')

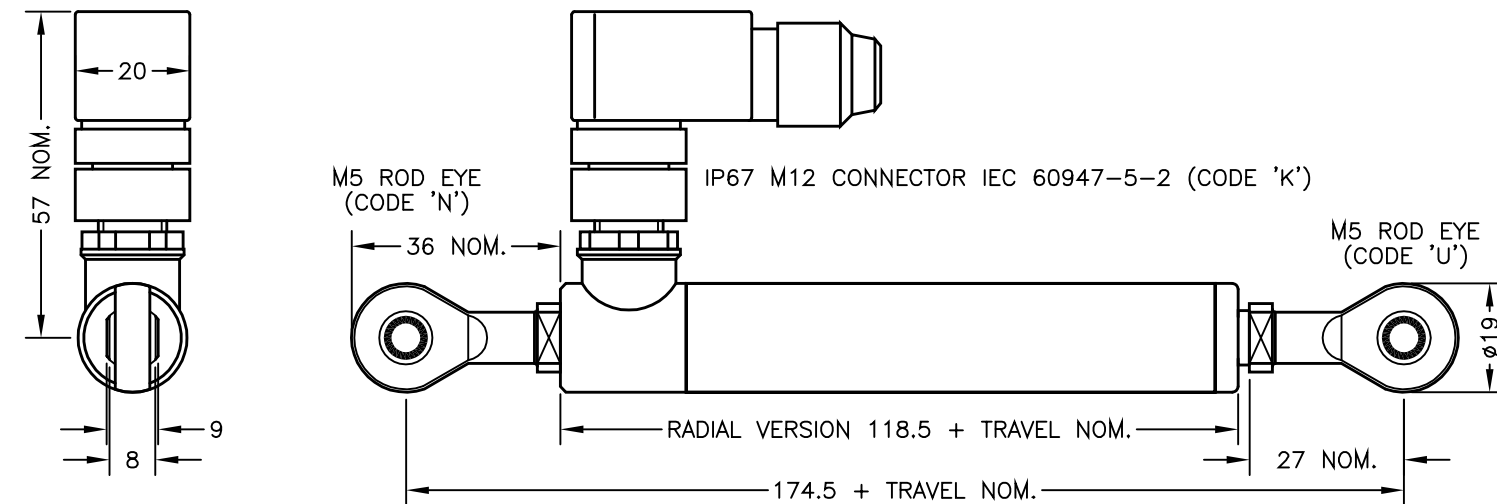
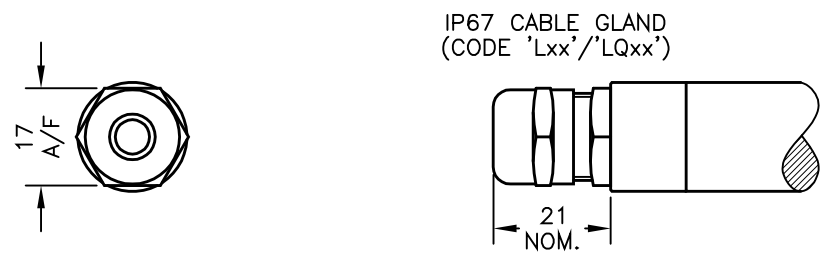
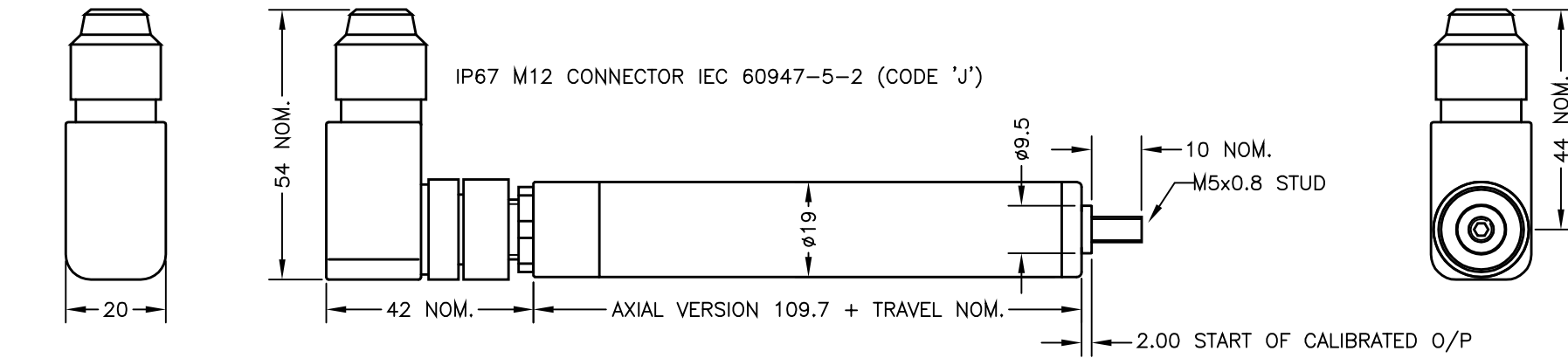

NOTE:- READ INSTALLATION SHEET E117-19 FOR FULL INSTRUCTIONS FOR USE.

ATEX / IECEx APPROVED TO

 II 1GD

Ex ia IIC T4 Ga (Ta= -40° to +80°C)  
 Ex ia IIIC T135°C Da (Ta= -40° to +80°C)  
 Ui 11.4V, Ii 0.2A, Pi 0.51W

APPROVED FOR USE IN CONJUNCTION WITH A GALVANICALLY ISOLATED BARRIER.

NOTE: APPROVAL ONLY APPLIES AT NORMAL ATMOSPHERIC PRESSURE!



F	RANGE WAS 10-350mm RAN1056	RDS
G	PUSH-ROD DIA. ADDED ~ RAN1083	PDM
H	5-CORE OPTION ADDED ~ RAN1102	PDM
J	RANGE NOTE AMENDED ~ RAN1200	PDM

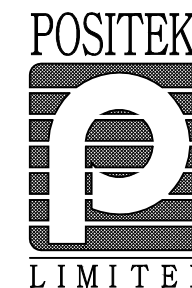

THE PUSH-ROD RETRACTS AND EXTENDS 2mm NOM. AT EITHER END OF CALIBRATED TRAVEL.  
 'V' CODED PUSH-ROD WILL DEPART SENSOR BODY.

DRAWINGS NOT TO BE CHANGED WITHOUT REFERENCE TO THE CHANGE PROCEDURE.  
 CHANGES TO PARTS USED IN INTRINSICALLY SAFE PRODUCT MUST BE APPROVED BY THE AUTHORISED PERSON  
 THIS IS AN UNCONTROLLED PRINT AND WILL NOT BE UPDATED.

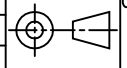

F	9/11/15		CHECKED BY	X	±0.4
G	13/04/16		RDS	X.X	±0.2
H	24/04/17			X.XX	±0.1
J	06/09/17				DIMS mm
		DESCRIPTION			
		E117 INTRINSICALLY SAFE SLIM-LINE LINEAR POSITION SENSOR			
SCALE		DRAWING NUMBER		REV	
12.5mm		E117-11		J	
				SHEET 1 OF 1	